



HONGJU HONGJU METAL

Zhongshan HongJu Metal Products Co., Ltd.



COMPANY INTRODUCTION

公司简介

专业化
Specialized

国际化
Internationalization

品牌化
Branding

中山市宏巨金属制品有限公司成立于2011年，座落在广东省中山市神湾镇，交通便利，地处珠江三角洲西南部，东邻三乡镇，南接坦洲镇，北靠板芙镇、五桂山镇，西与珠海斗门区隔江相望，公司注册资本500万，厂房面积5000多方，有独立的员工生活区，拥有高素质的技术队伍，大部分技术骨干具有十年以上的行业经验。

本公司是一家集专业生产、研发优质钢珠滑轨及家具五金为一体的现代化工业企业。生产的主要有：17、27、35、40、45、53、76系列滑轨，包括镀锌板、不锈钢、铝型材、冷轧钢材质滑轨。我们的滑轨不仅静音、顺畅度好，而且寿命长等各方面优势，广泛应用到家具、电器、工业设备、金融设备、汽车、IT等行业，是美的、戴尔、全友、夏普、东风、本田、丰田、日产等国内外知名企业的供应商。本公司可为客户提供专业设计、定制服务。

宏巨金属已建立了科学全面的企业管理和质量管理体系，通过了IATF16949认证，设定了严格的生产标准来监控每一个生产工序。公司使用全球领先的信息管理软件，形成了支撑公司经营运作和管理控制基本信息化的架构，使公司管理更加精细化。公司采用各种先进的生产设备，拥有行业领先的台湾引进的高精度滑轨滚压成型冲孔一体化自动生产线、全自动滑轨组装生产线。

COMPANY INTRODUCTION

公司简介

Zhongshan HongJu metal products Co., Ltd. was founded in 2011, located in Building A, No.7 Fuyuan Road, Nansha Industrial Zone, Shenwan Town, Zhongshan City, Guangdong Province, China. The company registered capital of RMB 5 million, the plant area of more than 5000 square meters. The company has an independent staff quarters and high-quality technical team, most of the technical backbone with 10 years of industry experience.

HongJu Metal is a professional production, research and development of high-quality rail and furniture hardware as one of the modern industrial enterprises. Slide products mainly include: 17 series, 27 series, 35 series, 40 series, 45 series, 53 series, 76 series slide, material include Cold rolled steel, Aluminum, stainless steel, Galvanized Sheet etc. The product are not only quiet, smooth, and long service life, but widely used in furniture, electrical appliances, industrial equipment, financial devices, automotive, IT and other industries. We can provide the OEM and ODM service. The company is a quality supplier of Midea, Dongfeng, Dell, Quanyou, SHARP, TOYOTA, HONDA, NISSAN and other well-known enterprises. We have established a scientific and comprehensive enterprise management and quality management system, passed IATF16949 certification, set strict production standard to monitor each production process. Using the world's leading information management software, the company has formed a basic information architecture which supports the operation and management.

Factory View 工厂视图



Certifications 资质认证



BALL BEARING RUNNERS SUPPLIER



HJ-1701

产品参数 Product parameters

17 二节滑轨 17mm Two- Section Slide Rails		HJ-1701
长度 Length		100-500mm
材质 Material		冷轧带钢 Q235 Cold Rolled Steel Q235
表面处理 Surface Finish		电镀, 电泳 Blue/Black Zinc plated
用途 Application		机械类 Machinery
材料厚度 Thickness		1.0mm
拉出 Extension		半抽拉 Half Extension
承重 Load Capacity		5KG

结构图
Drawing

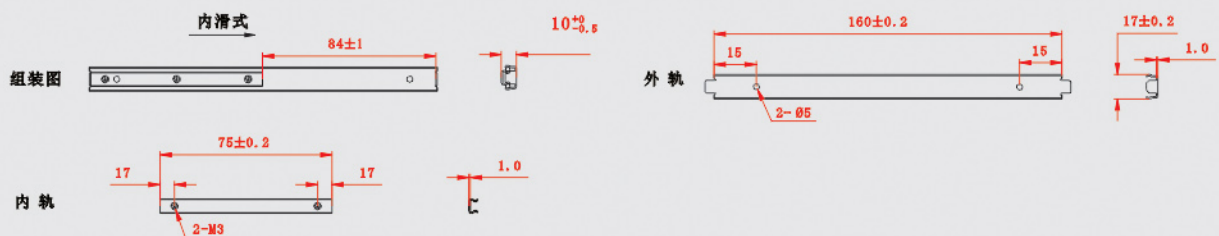



HJ-1702

产品参数 Product parameters

17 二节双通滑轨 17mm Two- Way Slide Rails		HJ-1702
长度 Length	80-300mm	
材质 Material	冷轧带钢 Q235 Cold Rolled Steel Q235	
表面处理 Surface Finish	电镀, 电泳 Blue/Black Zinc plated	
用途 Application	抽油烟机 Range Hood	
材料厚度 Thickness	1.0mm	
拉出 Extension	半抽拉 Half Extension	
承重 Load Capacity	5KG	

**结构图
Drawing**

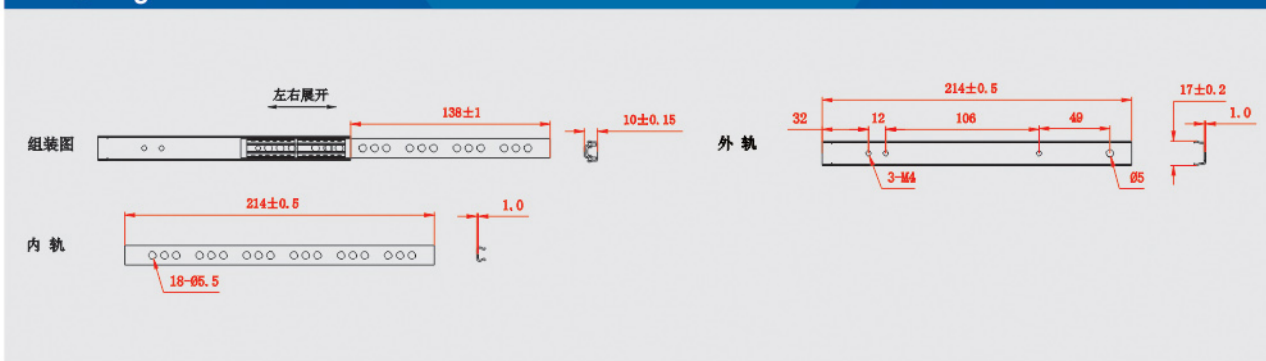



HJ-1601

产品参数 Product parameters

16 二节铝滑轨 16mm Two- Section Aluminum Slide Rails		HJ-1601
长度 Length	60-400mm	
材质 Material	铝型材 Aluminum	
用途 Application	珠宝箱、小电器 Jewel Box、 Motor Driver	
材料厚度 Thickness	4.0mm	
拉出 Extension	半抽拉 Half Extension	
承重 Load Capacity	5KG	

结构图
Drawing

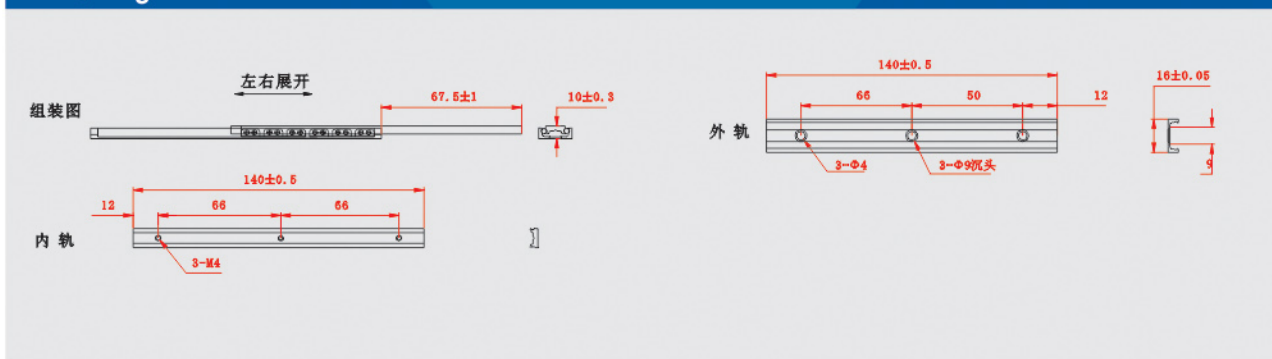



HJ-2001

产品参数 Product parameters

20 双层滑轨 20mm Double Row Slide Rails		HJ-2001
长度 Length	80-500mm	
材质 Material	冷轧带钢 Q235 Cold Rolled Steel Q235	
表面处理 Surface Finish	电镀, 电泳 Blue/Black Zinc plated	
用途 Application	医疗器械 Medical Equipment	
材料厚度 Thickness	1.4mm	
拉出 Extension	全抽拉 Full Extension	
承重 Load Capacity	20KG	

结构图
Drawing

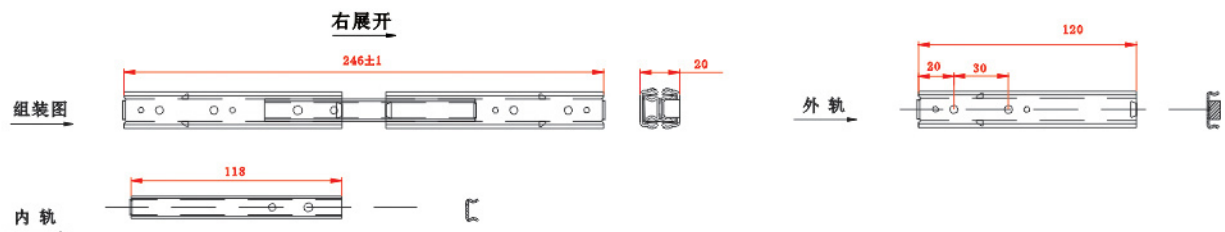



HJ-2703

产品参数 Product parameters

27 双层滑轨 27mm Double Row Slide Rails		HJ-2703
长度 Length	100-450mm	
材质 Material	冷轧带钢 Q235 Cold Rolled Steel Q235	
表面处理 Surface Finish	电镀, 电泳 Blue/Black Zinc plated	
用途 Application	家具、电器 Household Appliances、Furniture	
材料厚度 Thickness	1.4mm	
拉出 Extension	全抽拉 Full Extension	
承重 Load Capacity	50KG	

结构图
Drawing

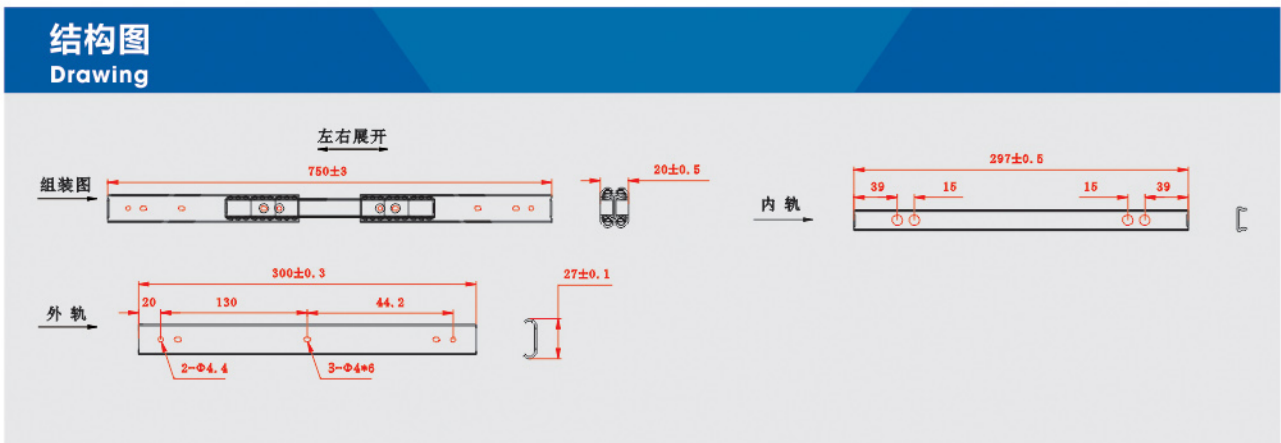



HJ-2704

产品参数 Product parameters

27 汽车滑轨 27mm Armrest Slide Rails		HJ-2704
长度 Length	100-300mm	
材质 Material	冷轧带钢 Q235 Cold Rolled Steel Q235	
表面处理 Surface Finish	电镀, 电泳 Blue/Black Zinc plated	
用途 Application	汽车扶手箱 Car Console Box	
材料厚度 Thickness	1.4mm	
拉出 Extension	半抽拉 Half Extension	
承重 Load Capacity	50KG	

结构图
Drawing

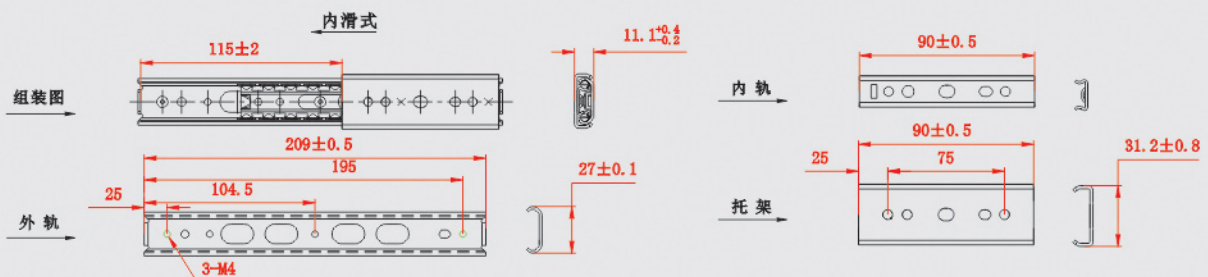



HJ-2705



HJ-2706

产品参数 Product parameters

27 二节不锈钢烤箱滑轨 27mm Oven Two- Section Stainless Steel Slide Rails	
长度 Length	300-500mm
材质 Material	304不锈钢 SUS304
用途 Application	烤箱 Oven
材料厚度 Thickness	1.2mm
拉出 Extension	半抽拉 Half Extension
承重 Load Capacity	30KG

27 双层不锈钢烤炉滑轨 27mm Oven Double Row Stainless Steel Slide Rails	
长度 Length	300-500mm
材质 Material	304不锈钢 SUS304
用途 Application	烤箱 Oven
材料厚度 Thickness	1.2mm
拉出 Extension	全抽拉 Full Extension
承重 Load Capacity	40KG

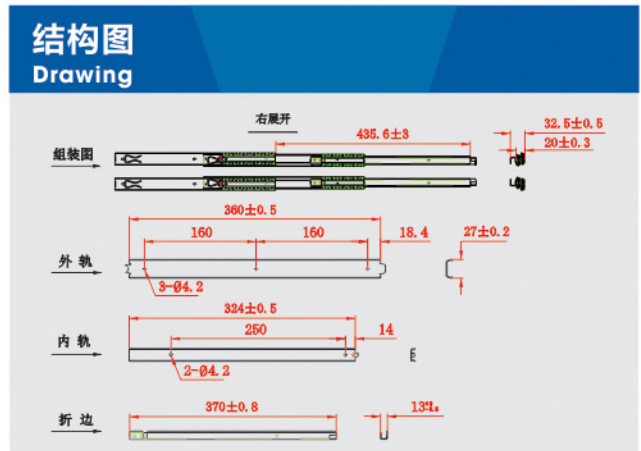
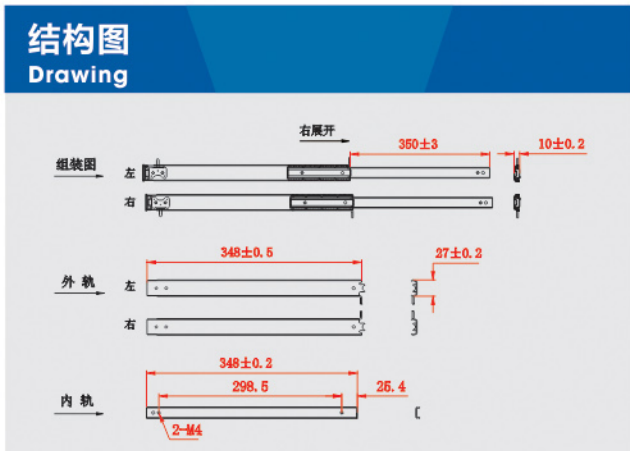



HJ-3501

产品参数 Product parameters

35二节滑轨 35mm Two-Section Slide Rails		HJ-3501
长度 Length	250-500mm	
材质 Material	冷轧带钢 Q235 Cold Rolled Steel Q235	
表面处理 Surface Finish	电镀, 电泳 Blue/Black Zinc plated	
用途 Application	医疗康复器械 Medical Equipment	
材料厚度 Thickness	1.4*1.4mm	
拉出 Extension	半抽拉 Half Extension	
承重 Load Capacity	40KG	

结构图
Drawing

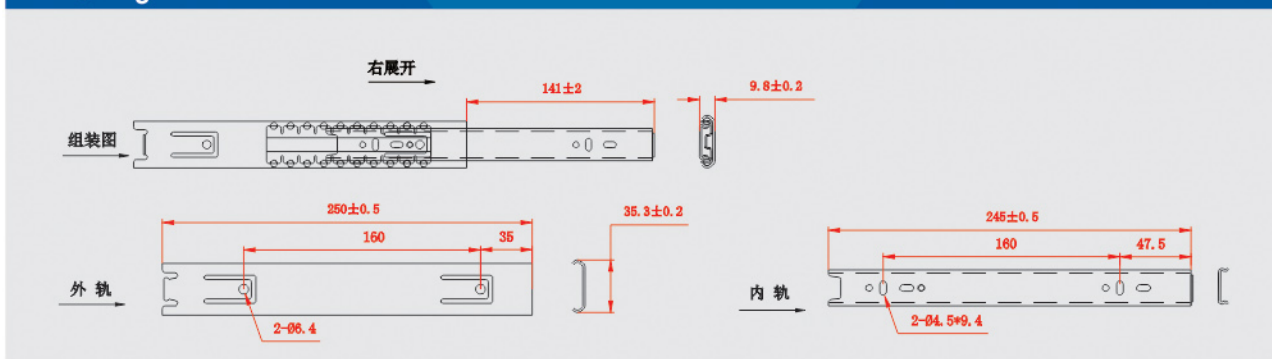



HJ-3502



HJ-3506

产品参数 Product parameters

35 合页滑轨 35mm Two-Section Hinge Slide Rails	
长度 Length	250-550mm
材质 Material	冷轧带钢Q235 Cold Rolled Steel Q235
表面处理 Surface Finish	电镀, 电泳 Blue/Black Zinc plated
用途 Application	家具、电器 Household Appliances、Furniture
材料厚度 Thickness	1.4*1.4mm
拉出 Extension	半抽拉 Half Extension
承重 Load Capacity	40KG

35 二节键盘滑轨 35mm Two-Section Keyboard Tray Slide Rails	
长度 Length	250-550mm
材质 Material	冷轧带钢Q235 Cold Rolled Steel Q235
表面处理 Surface Finish	电镀, 电泳 Blue/Black Zinc plated
用途 Application	办公家具 Office Furniture
材料厚度 Thickness	1.4*1.4mm
拉出 Extension	半抽拉 Half Extension
承重 Load Capacity	40KG

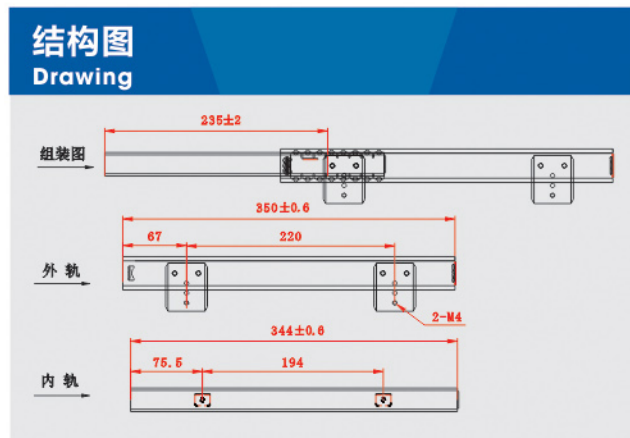
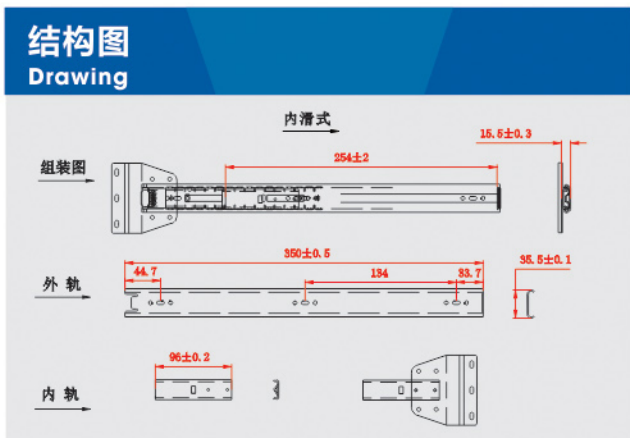



HJ-3503

产品参数 Product parameters

35 二节内滑式 35mm Two- Section Inner Slide Rails

HJ-3503

长度 Length	250-500mm
材质 Material	冷轧带钢 Q235 Cold Rolled Steel Q235
表面处理 Surface Finish	电镀, 电泳 Blue/Black Zinc plated
用途 Application	电器 Household Appliances
材料厚度 Thickness	1.4*1.4mm
拉出 Extension	半抽拉 Half Extension
承重 Load Capacity	40KG

结构图 Drawing

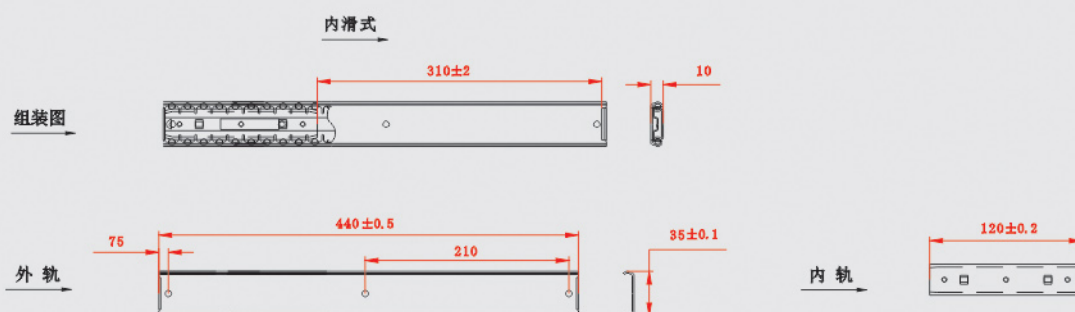



HJ-3505

产品参数 Product parameters

35 双层挂钩滑轨 35mm Double Row Slide Rails with Pothook		HJ-3505
长度 Length	250-500mm	
材质 Material	冷轧带钢 Q235 Cold Rolled Steel Q235	
表面处理 Surface Finish	电镀, 电泳 Blue/Black Zinc plated	
用途 Application	铁制家具 Toolbox, Iron Furniture	
材料厚度 Thickness	1.4*1.4mm	
拉出 Extension	全抽拉 Full Extension	
承重 Load Capacity	35KG	

结构图
Drawing

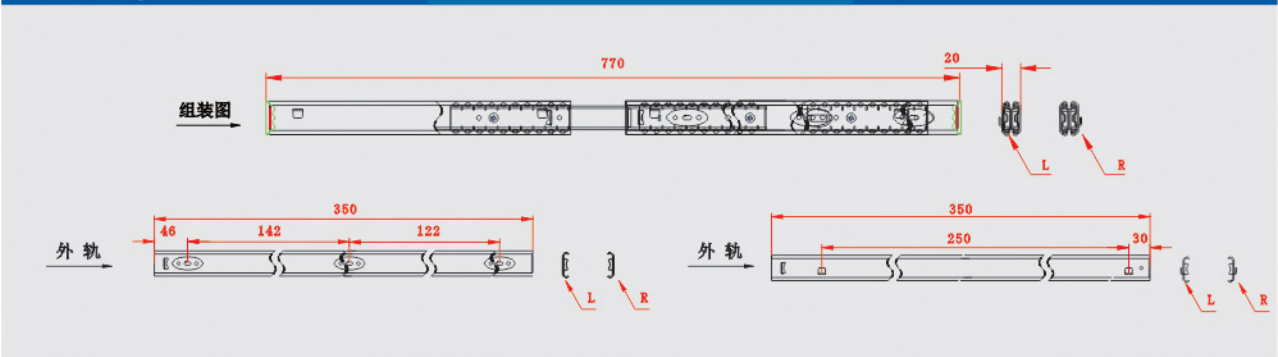



HJ-3507

产品参数 Product parameters

35 双排滑轨 35mm Double Tiered Slide Rails		HJ-3507
长度 Length	300-850mm	
材质 Material	冷轧带钢 Q235 Cold Rolled Steel Q235	
表面处理 Surface Finish	电镀, 电泳 Blue/Black Zinc plated	
用途 Application	美式家具 American Furniture	
材料厚度 Thickness	1.4*1.4mm	
拉出 Extension	全抽拉 Full Extension	
承重 Load Capacity	60KG	

结构图
Drawing

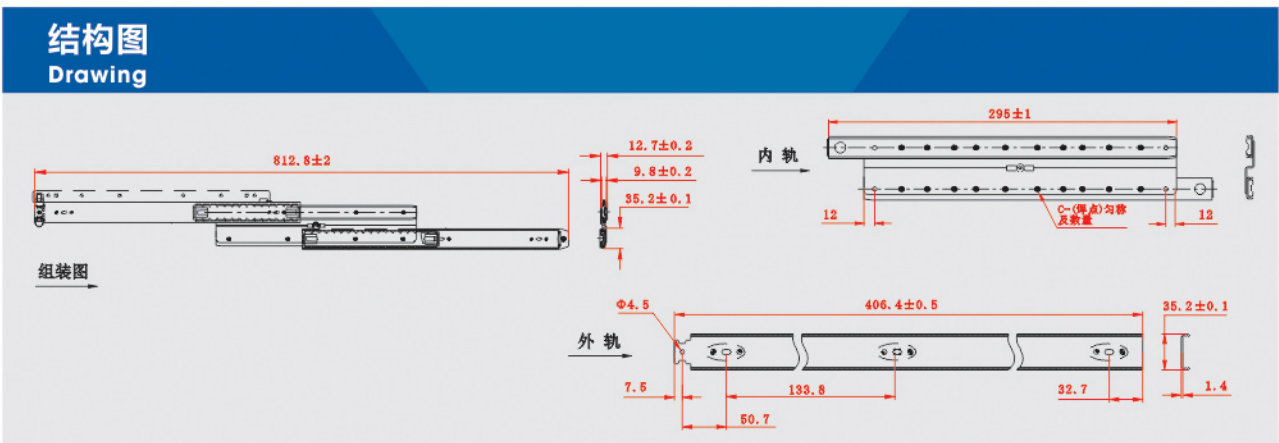



HJ-3513

产品参数 Product parameters

35 两节13mm高拉篮滑轨 35mm Two-Section Heighten Slide Rails		HJ-3513
长度 Length	350-500mm	
材质 Material	冷轧带钢 Q235 Cold Rolled Steel Q235	
表面处理 Surface Finish	电镀, 电泳 Blue/Black Zinc plated	
用途 Application	家具拉篮 Kitchen Wire Rack	
材料厚度 Thickness	1.4*1.5*1.5mm	
拉出 Extension	半轴拉 Half Extension	
承重 Load Capacity	50KG	

结构图
Drawing

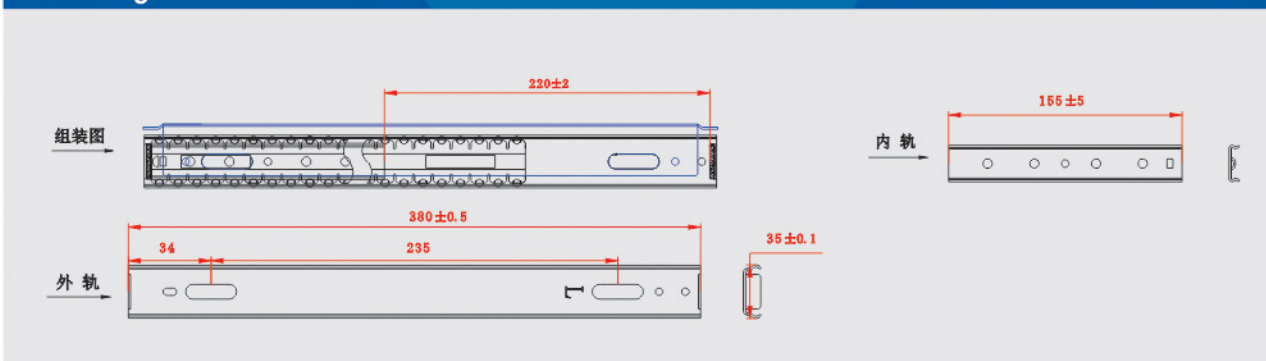



HJ-3535



HJ-4001

产品参数 Product parameters

35 双排双层滑轨 35mm Double Tiered Double Row Slide Rails		40 双排滑轨 40mm Double Tiered Slide Rails	
长度 Length	300-900mm	长度 Length	400-700mm
材质 Material	冷轧带钢Q235 Cold Rolled Steel Q235	材质 Material	冷轧带钢Q235 Cold Rolled Steel Q235
表面处理 Surface Finish	电镀, 电泳 Blue/Black Zinc plated	表面处理 Surface Finish	电镀, 电泳 Blue/Black Zinc plated
用途 Application	重型机械 Heavy-duty Machinery	用途 Application	重型机械 Heavy-duty Machinery
材料厚度 Thickness	1.4*1.4mm	材料厚度 Thickness	1.8*2.0*2.0mm
拉出 Extension	全抽拉 Full Extension	拉出 Extension	全抽拉 Full Extension
承重 Load Capacity	100KG	承重 Load Capacity	100KG



HJ-4501

产品参数 Product parameters

45 三节挂钩滑轨 45mm Three-Section with hook Slide Rails		HJ-4501
长度 Length	250-900mm	
材质 Material	冷轧带钢 Q235 Cold Rolled Steel Q235	
表面处理 Surface Finish	电镀, 电泳 Blue/Black Zinc plated	
用途 Application	木制、铁制家具 Furniture	
材料厚度 Thickness	1.0*1.0*1.2mm	
拉出 Extension	全抽拉 Full Extension	
承重 Load Capacity	40KG	

结构图
Drawing

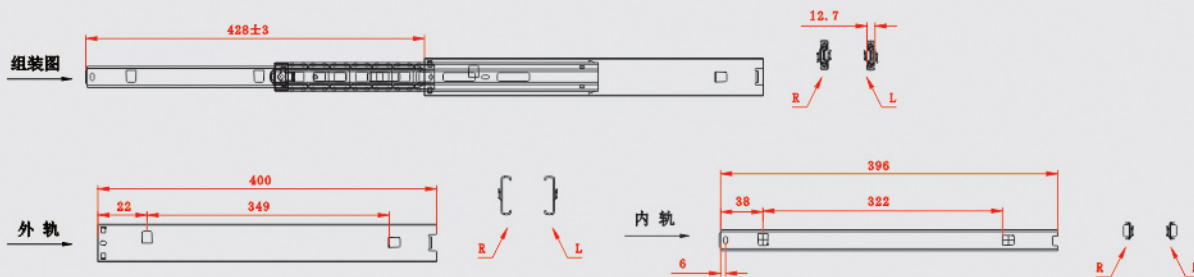



HJ-4502

产品参数 Product parameters

45 三节滑轨 45mm Three-Section Slide Rails		HJ-4502
长度 Length	250-900mm	
材质 Material	冷轧带钢 Q235 Cold Rolled Steel Q235	
表面处理 Surface Finish	电镀, 电泳 Blue/Black Zinc plated	
用途 Application	木, 铁质家具, 电器 Furniture, Household Appliances	
材料厚度 Thickness	1.2*1.2*1.4mm	
拉出 Extension	全抽拉 Full Extension	
承重 Load Capacity	50KG	

结构图
Drawing

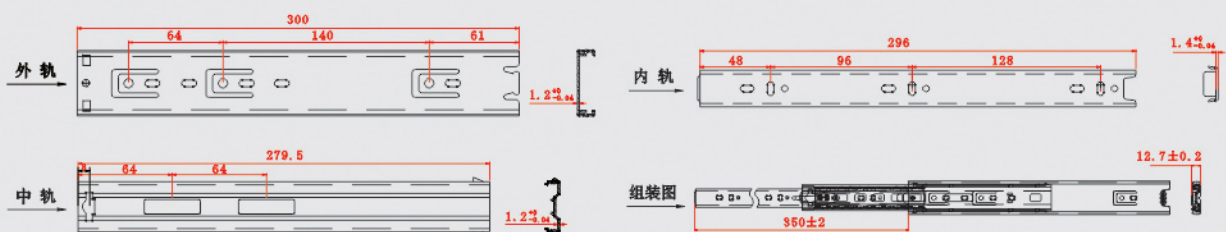



HJ-4503

产品参数 Product parameters

45 三节反弹滑轨 45mm Three-Section Push to Open Slide Rails		HJ-4503
长度 Length	250-800mm	
材质 Material	冷轧带钢 Q235 Cold Rolled Steel Q235	
表面处理 Surface Finish	电镀, 电泳 Blue/Black Zinc plated	
用途 Application	美式家具 American Furniture	
材料厚度 Thickness	1.0*1.0*1.2mm	
拉出 Extension	全抽拉 Full Extension	
承重 Load Capacity	50KG	

**结构图
Drawing**

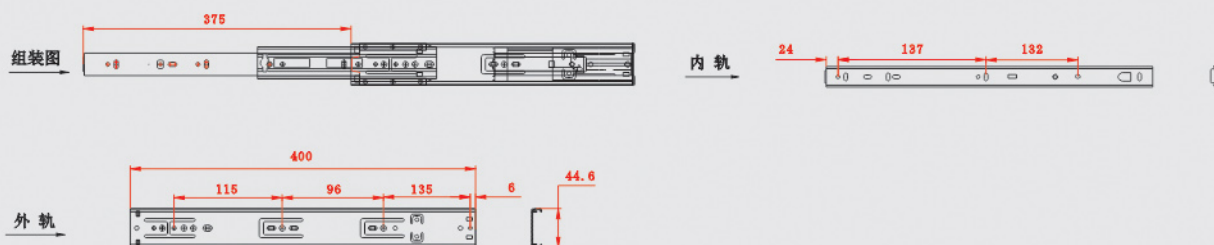

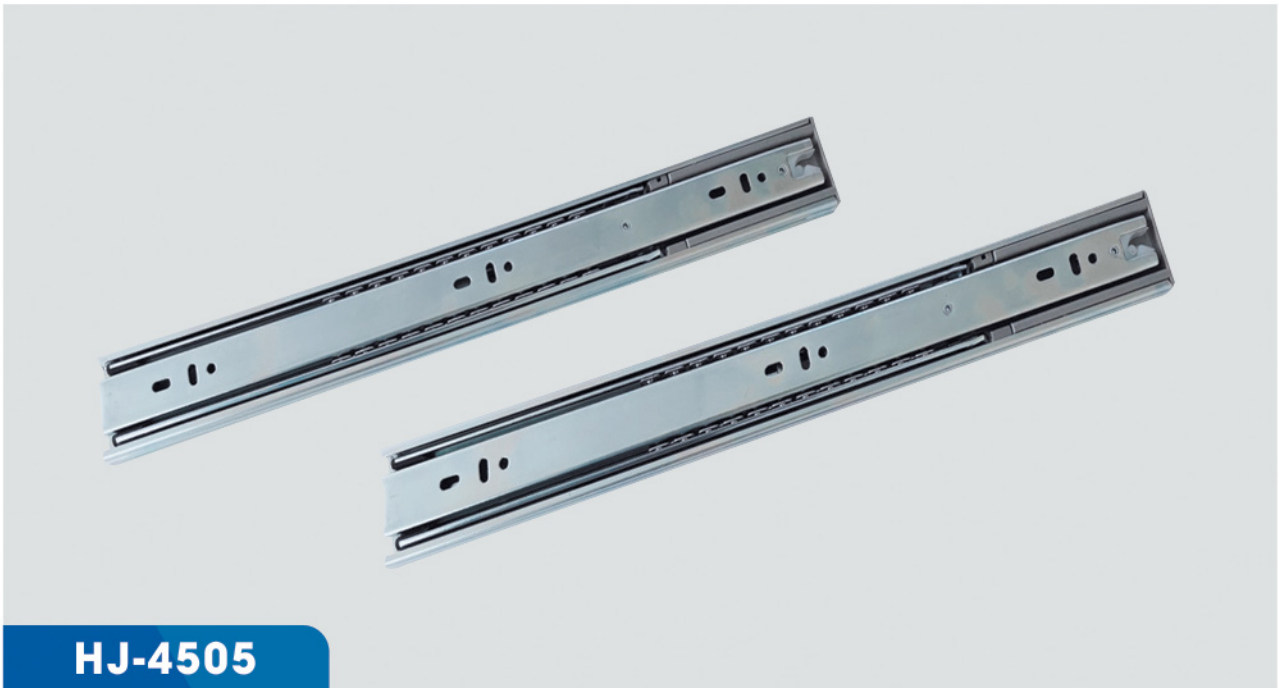

HJ-4505

产品参数 Product parameters

45 三节缓冲滑轨 45mm Three-Section Soft close Slide Rails		HJ-4505
长度 Length		250-700mm
材质 Material		冷轧带钢 Q235 Cold Rolled Steel Q235
表面处理 Surface Finish		电镀, 电泳 Blue/Black Zinc plated
用途 Application		家具 Furniture
材料厚度 Thickness		1.2*1.2*1.4mm
拉出 Extension		全抽拉 Full Extension
承重 Load Capacity		50KG

结构图
Drawing

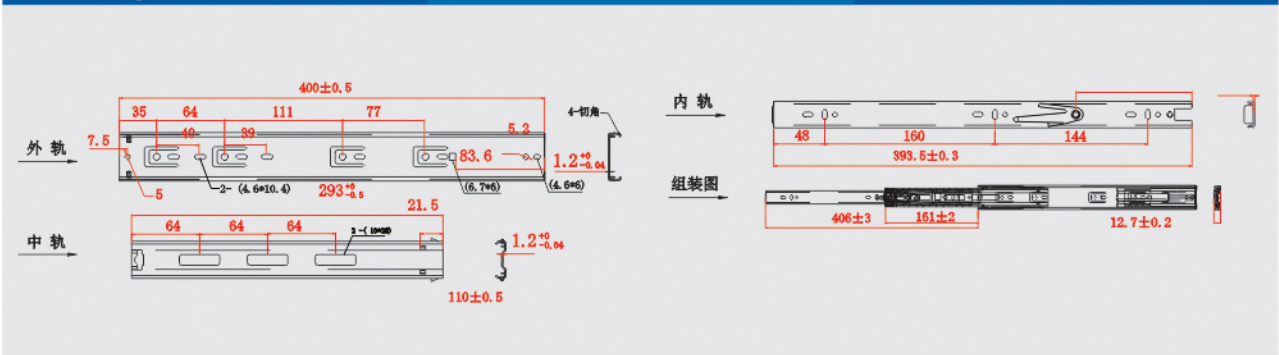



HJ-4504



HJ-4508

产品参数 Product parameters

45 三节自闭滑轨 45mm Three-Section Self-Locking Slide Rails	
长度 Length	250-700mm
材质 Material	冷轧带钢Q235 Cold Rolled Steel Q235
表面处理 Surface Finish	电镀, 电泳 Blue/Black Zinc plated
用途 Application	铁制家具 Iron Furniture
材料厚度 Thickness	1.2*1.2*1.4
拉出 Extension	全抽拉 Full Extension
承重 Load Capacity	50KG

45 三节高深拉篮滑轨 45mm Three-Section Heighten Slide Rails	
长度 Length	350-550mm
材质 Material	冷轧带钢Q235 Cold Rolled Steel Q235
表面处理 Surface Finish	电镀, 电泳 Blue/Black Zinc plated
用途 Application	厨卫拉篮 Kitchen Wire Rack
材料厚度 Thickness	1.2*1.2*1.4
拉出 Extension	全抽拉 Full Extension
承重 Load Capacity	50KG

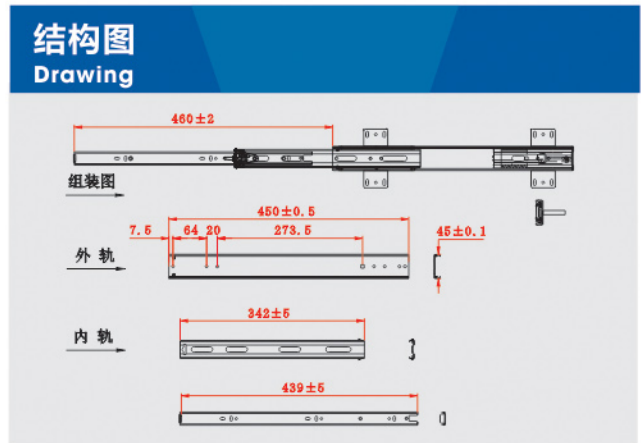
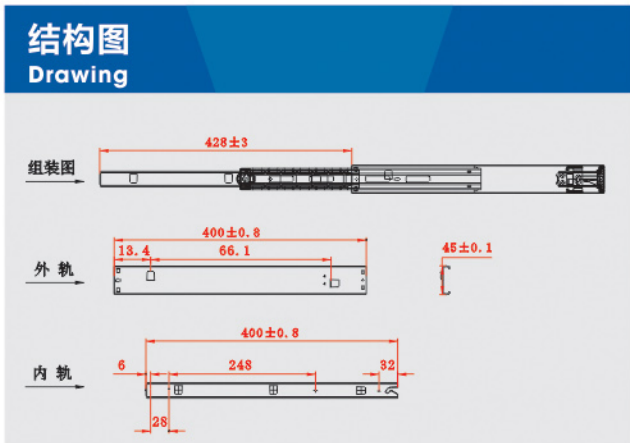



HJ-4506

产品参数 Product parameters

45 三节外侧脚滑轨 45mm Three-Section Pull Out Shelf Slide Rails		HJ-4506
长度 Length	300-600mm	
材质 Material	冷轧带钢 Q235 Cold Rolled Steel Q235	
表面处理 Surface Finish	电镀, 电泳 Blue/Black Zinc plated	
用途 Application	厨卫拉篮 Kitchen Wire Rack	
材料厚度 Thickness	1.2*1.2*1.4mm	
拉出 Extension	全抽拉 Full Extension	
承重 Load Capacity	50KG	

结构图
Drawing

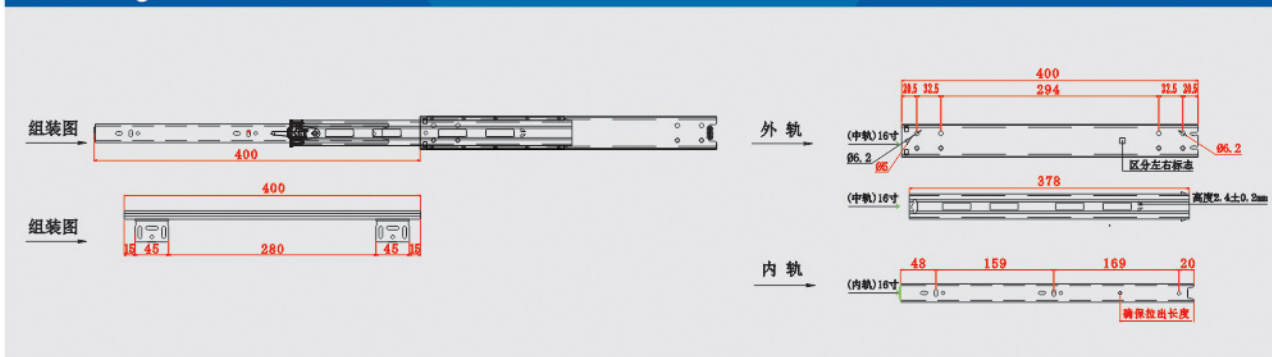



HJ-4507

产品参数 Product parameters

45 三节拉篮滑轨		HJ-4507
45mm Three-Section Slide Rails for kitchen wire rack		
长度 Length	300-600mm	
材质 Material	冷轧带钢 Q235 Cold Rolled Steel Q235	
表面处理 Surface Finish	电镀, 电泳 Blue/Black Zinc plated	
用途 Application	厨卫拉篮 Kitchen Wire Rack	
材料厚度 Thickness	1.2*1.2*1.4mm	
拉出 Extension	全抽拉 Full Extension	
承重 Load Capacity	50KG	

结构图
Drawing

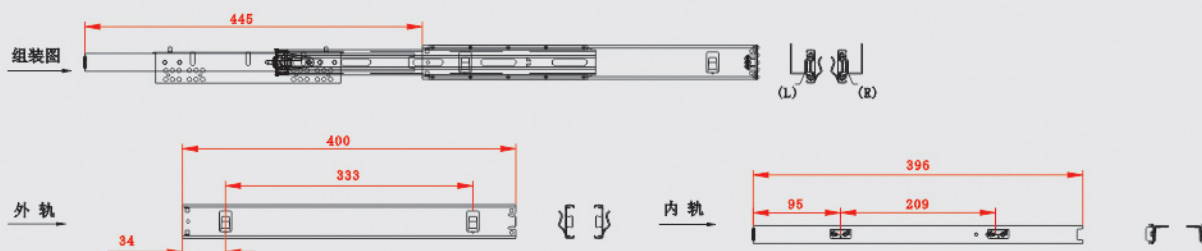

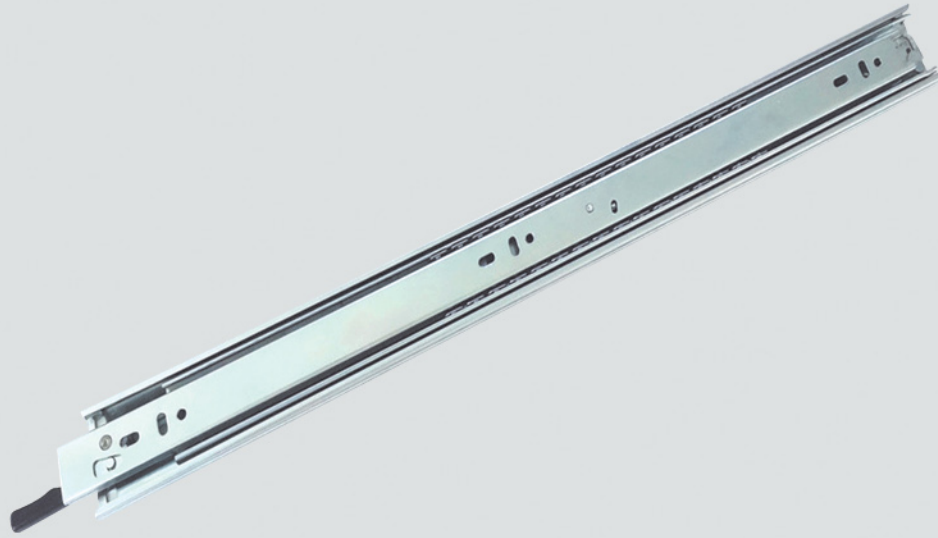

HJ-4509

产品参数 Product parameters

45 三节自锁滑轨

45mm Three-Section Self-Locking Slide Rails

HJ-4509

长度 Length	350-550mm
材质 Material	冷轧带钢 Q235 Cold Rolled Steel Q235
表面处理 Surface Finish	电镀, 电泳 Blue/Black Zinc plated
用途 Application	车载专用、机器设备 Vehicle only、Machinery Equipment
材料厚度 Thickness	1.2*1.2*1.4mm
拉出 Extension	全抽拉 Full Extension
承重 Load Capacity	50KG

结构图

Drawing

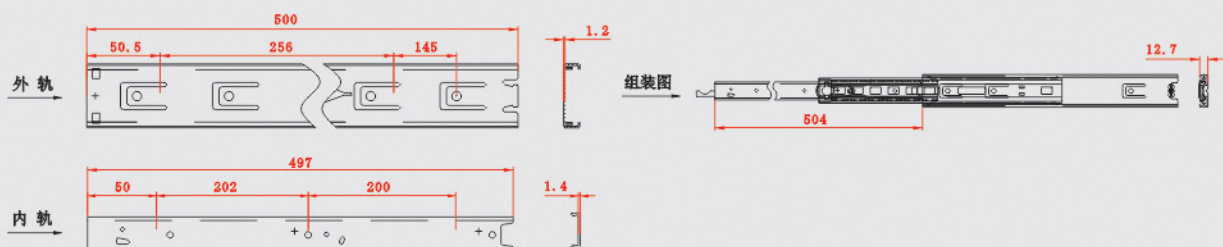



HJ-5301

产品参数 Product parameters

53 三节缓冲滑轨 53mm Three-Section Soft close Slide Rails		HJ-5301
长度 Length	300-1500mm	
材质 Material	冷轧带钢 Q235 Cold Rolled Steel Q235	
表面处理 Surface Finish	电镀, 电泳 Blue/Black Zinc plated	
用途 Application	铁柜、机器设备 Toolbox、Mechinery	
材料厚度 Thickness	2.0*2.0*2.0mm	
拉出 Extension	全抽拉 Full Extension	
承重 Load Capacity	100KG	

**结构图
Drawing**

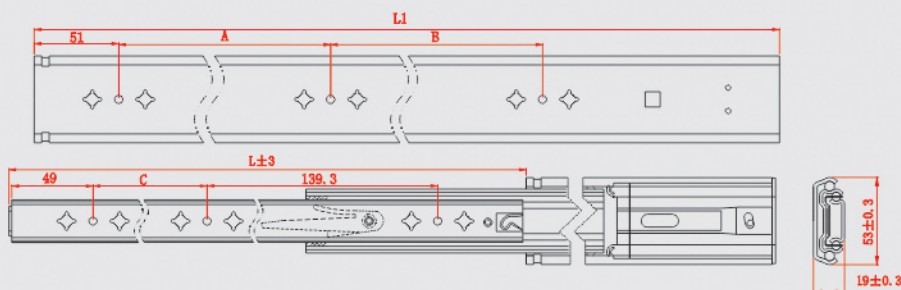



HJ-5302

产品参数 Product parameters

53 三节自锁滑轨
53mm Three-Section Self-Locking Slide Rails

HJ-5302

长度 Length	350-1500mm
材质 Material	冷轧带钢 Q235 Cold Rolled Steel Q235
表面处理 Surface Finish	电镀, 电泳 Blue/Black Zinc plated
用途 Application	铁柜、车载专用、机器设备 Toolbox、 Vehicle special、 Machinery
材料厚度 Thickness	2.0*2.0*2.0mm
拉出 Extension	全抽拉 Full Extension
承重 Load Capacity	100KG

结构图
Drawing

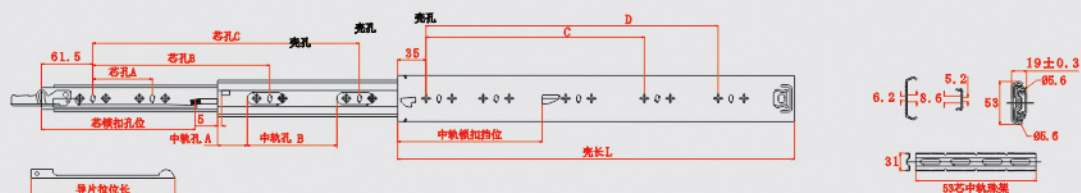



HJ-7601

产品参数 Product parameters

76 三节自锁重型滑轨

76mm Three-Section Self-Locking Heavy Duty Slide Rails

HJ-7601

长度 Length	350-1800mm
材质 Material	冷轧带钢 Q235 Cold Rolled Steel Q235
表面处理 Surface Finish	电镀, 电泳 Blue/Black Zinc plated
用途 Application	铁柜、车载专用、机器设备 Toolbox、 Vehicle special、 Machinery
材料厚度 Thickness	2.5*2.2*2.5mm
拉出 Extension	全抽拉 Full Extension
承重 Load Capacity	150KG

结构图 Drawing

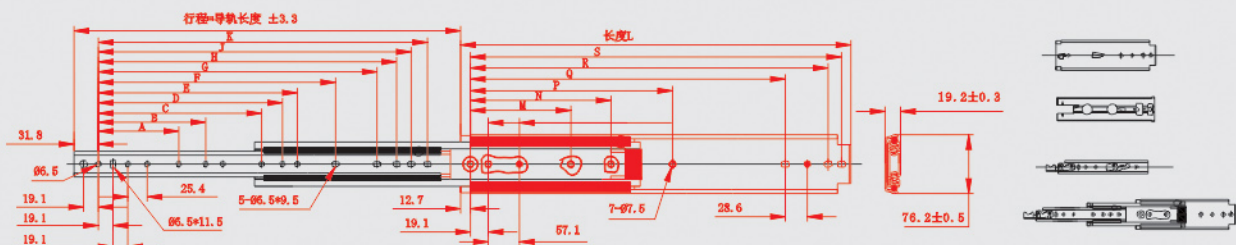



HJ-7602

产品参数 Product parameters

76 三节重型滑轨 76mm Three-Section Heavy Duty Slide Rails		HJ-7602
长度 Length	350-1800mm	
材质 Material	冷轧带钢 Q235 Cold Rolled Steel Q235	
表面处理 Surface Finish	电镀, 电泳 Blue/Black Zinc plated	
用途 Application	重型机械 Heavy-duty Machinery	
材料厚度 Thickness	2.5*2.2*2.5mm	
拉出 Extension	全抽拉 Full Extension	
承重 Load Capacity	150KG	

**结构图
Drawing**

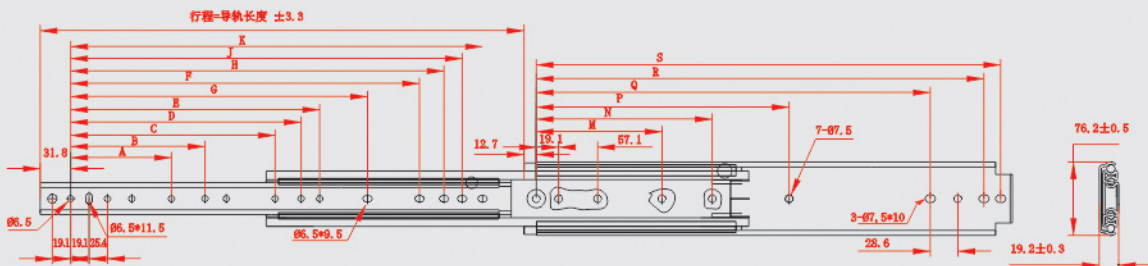



HJ-668



HJ-886

产品参数 Product parameters

三节托底隐藏滑轨 Hidden Bottom Three-Section Slide Rails		三节托底隐藏滑轨 Hidden Bottom Three-Section Slide Rails	
长度 Length	300-500mm	长度 Length	300-500mm
材质 Material	镀锌板 Galvanized Sheet	材质 Material	镀锌板 Galvanized Sheet
用途 Application	家具 Furniture	用途 Application	美式家具 American Furniture
材料厚度 Thickness	1.2*1.5*1.8mm	材料厚度 Thickness	1.2*1.5*1.8mm
拉出 Extension	全抽拉 Full Extension	拉出 Extension	全抽拉 Full Extension
承重 Load Capacity	35KG	承重 Load Capacity	35KG

HJ-1001

HJ-1002

产品参数 Product parameters

滑轨前支架 Slide Rail Front Bracket		滑轨后支架 Slide Rail Back Bracket	
材质 Material	冷轧带钢Q235 Cold Rolled Steel Q235	材质 Material	冷轧带钢Q235 Cold Rolled Steel Q235
表面处理 Surface Finish	电镀, 电泳 Blue/Black Zinc plated	表面处理 Surface Finish	电镀, 电泳 Blue/Black Zinc plated
用途 Application	抽屉滑轨的前支架 Front Support for Drawer Slide	用途 Application	抽屉滑轨的后支架 Back Support for Drawer Slide
材料厚度 Thickness	1.0mm	材料厚度 Thickness	1.2mm
承重 Load Capacity	40KG	承重 Load Capacity	40KG

Ball Bearing Slide Rail Manufacturer

专业滑轨制造商



微信二维码

中山市宏巨金属制品有限公司

联系人：蔡先生 13715565715

电话：0760-86330031

传真：0760-86330030

邮箱：awfxoidr@163.com

地址：中山市神湾镇南沙大道福源路7号

网址：<http://www.hjs.ren> <http://www.hjslide.com>

Zhongshan HongJu Metal Products Co., Ltd.

Add : No.7 FuYuan Road, NanSha Industrial Zone,
ShenWan Town, ZhongShan City. GuangDong
Province, China

E-mail : sally@zshongju.com.cn

Tel : +86 13925333418